

# ZOMM Series

## (Zinc Oxide Military Modules)

### ZOMM 127/407/1/4



PD Devices Ltd manufacture a wide range of products to protect against the effects of high altitude detonation of Nuclear devices. The result of such an event is the generation of Electromagnetic Pulses which will induce a high voltage transient in exposed conductors.

The EMP can affect several thousands of square kilometres, with a magnitude of tens of kilovolts.

This could result in serious damage to insulation, cause breakdown of semiconductors and the consequent malfunction of critical equipment.

Most notable would be the failure of Energy Power Supply and Communications Systems. We offer products to satisfy protection for most applications



Specification	
No. of channels	4
50 Shot ( 4/20µs ) Repetitive Duty	1000A
Response Time	<10ns
Continuous Current per Channel	10A
Max. ( 8/20µs ) Current per Channel	6500A
Leakage Current per Channel at Rated Voltage, DC	<100µA
Through Inductance	<10µH
Volts Drop	Negligible
Terminations	3mm Dia Brass
Bushes	PTFE
Earth Connection	To Base Plate
Recommended Torque per M4 Terminal	1.0Nm ( Ensure terminal does not rotate )

#### Explanation of Order Code

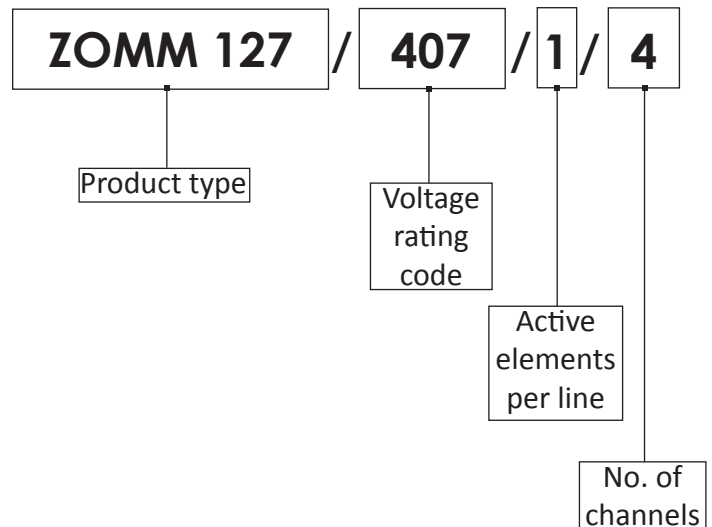

PD Devices reserves the right to amend specifications in line with product development.

(XXX)		*400	*401	402	403	404	405	406	407	408	409	410	411
Continuous Operating Voltage	AC (rms)	50	60	95	110	120	135	150	180	220	250	280	320
Energy per channel (Joules)	(10/1000µs)	28	35	50	55	65	75	80	90	110	130	140	150
Max. Peak Clamping Volts @	50A (8/20µs)	180	210	-	-	-	-	-	-	-	-	-	-
Max. Peak Clamping Volts @	100A (8/20µs)	-	-	250	310	330	380	420	525	650	710	825	910

Revision: vPD1, 25/05/18  
Information subject to change without notice.

All of the above information, including drawings, illustrations and graphic designs, reflects our present understanding and is to the best of our knowledge and belief correct and reliable. Users, however, should independently evaluate the suitability of each product for the desired application.



# ZOMM Series

## (Zinc Oxide Military Modules)

### ZOMM 127/407/1/4



ZOMM 127/407/1/4 Diagram in mm

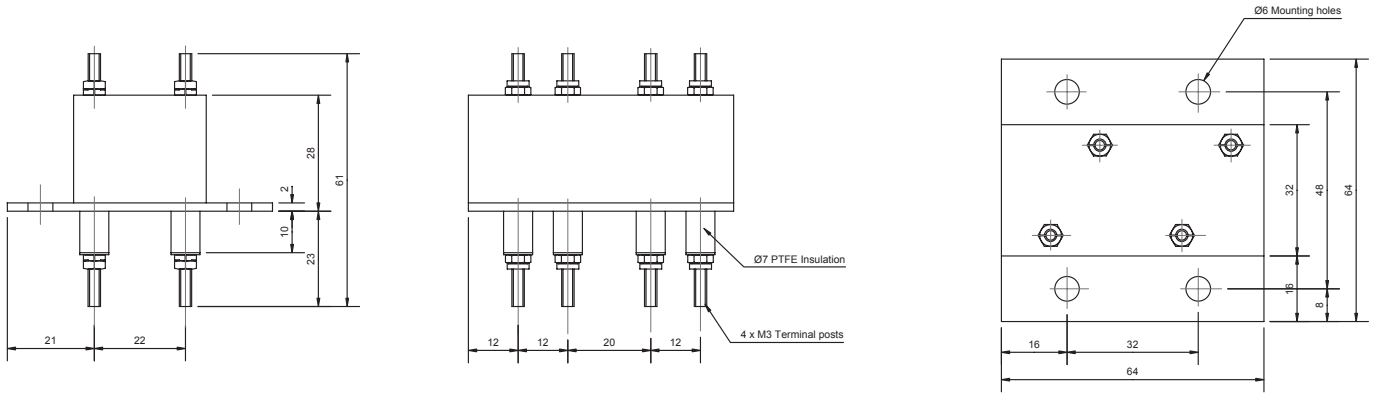

This ZOMM Application is recommended for Zone 1  
**\*Except Ref: 400 and 401**

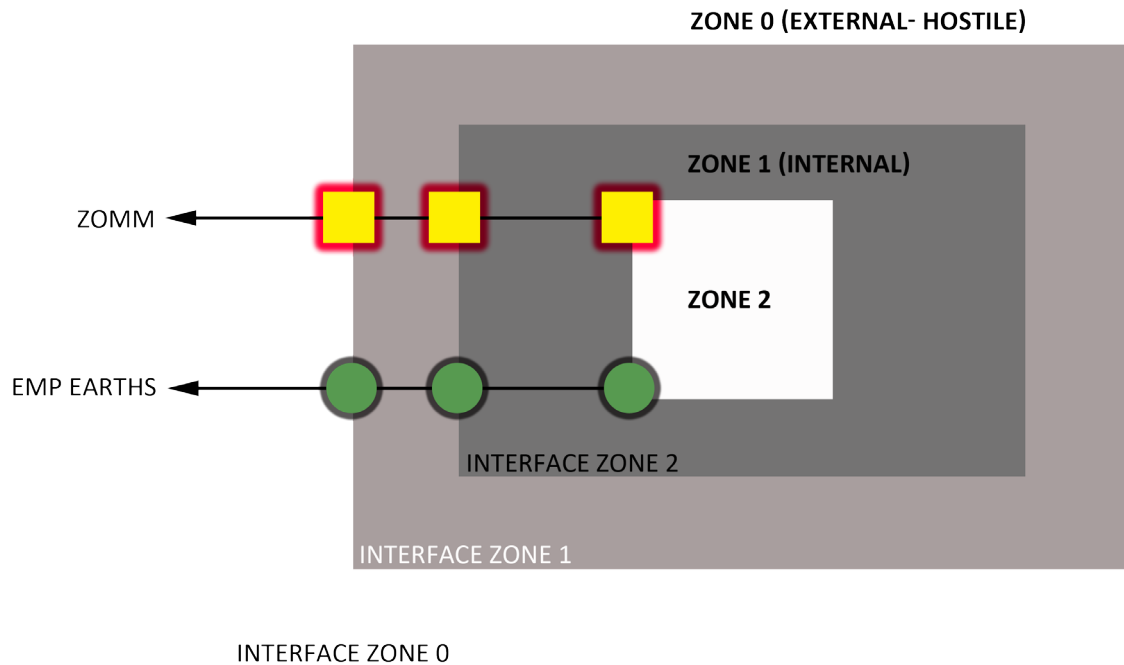

Revision: vPD1, 25/05/18  
 Information subject to change without notice.

All of the above information, including drawings, illustrations and graphic designs, reflects our present understanding and is to the best of our knowledge and belief correct and reliable. Users, however, should independently evaluate the suitability of each product for the desired application.

