

ZOMM Series

(Zinc Oxide Military Modules)

ZOMM 108/309/1/12



PD Devices Ltd manufacture a wide range of products to protect against the effects of high altitude detonation of Nuclear devices. The result of such an event is the generation of Electromagnetic Pulses which will induce a high voltage transient in exposed conductors.

The EMP can affect several thousands of square kilometres, with a magnitude of tens of kilovolts.

This could result in serious damage to insulation, cause breakdown of semiconductors and the consequent malfunction of critical equipment.

Most notable would be the failure of Energy Power Supply and Communications Systems. We offer products to satisfy protection for most applications



Specification	
No. of channels	12
50 Shot (4/20µs) Repetitive Duty	300A
Response Time	<10ns
Continuous Current per Channel	5A
Max. (8/20µs) Current per Channel	4500A
Leakage Current per Channel at Rated Voltage, DC	<50µA
Through Inductance	<10µH
Volts Drop	Negligible
Terminations	1mm H.D.H.C. Tinned Copper
Bushes	PTFE
Earth Connection	To Base Plate

Explanation of Order Code

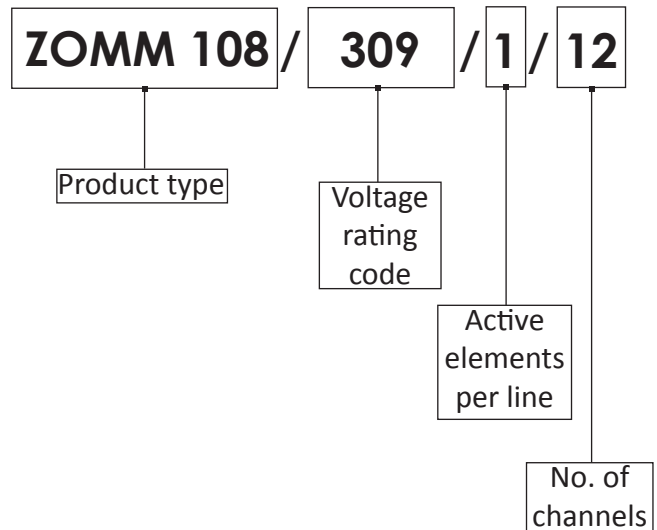

PD Devices reserves the right to amend specifications in line with product development.

Specification		
Continuous Operating Voltage	AC (rms)	250V
Continuous Operating Voltage	DC	325V
Energy per channel (Joules)	(10/1000µs)	85J
Max. Peak Clamping Volts @	50A (8/20µs)	710V
No. of channels	12	
Part Code:	ZOMM 108/309/1/12	

Revision: vPD2, 16/05/18
Information subject to change without notice.

All of the above information, including drawings, illustrations and graphic designs, reflects our present understanding and is to the best of our knowledge and belief correct and reliable. Users, however, should independently evaluate the suitability of each product for the desired application.



ZOMM Series

(Zinc Oxide Military Modules)

ZOMM 108/309/1/12



ZOMM 108/309/1/12 Diagram in mm

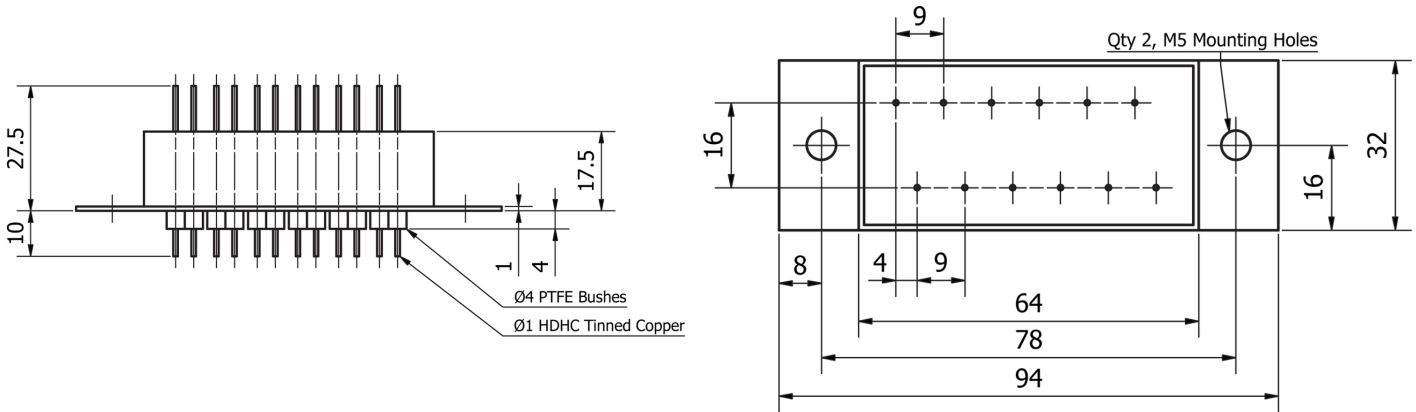

This ZOMM Application is recommended for Zone 2

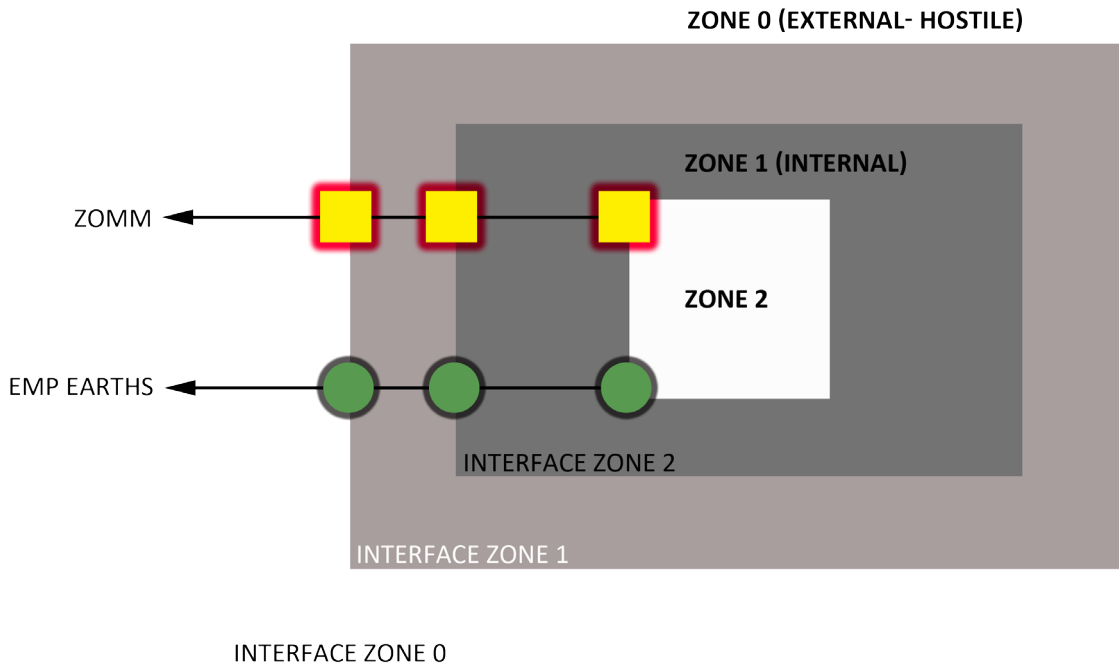

Revision: vPD2, 16/05/18
Information subject to change without notice.

All of the above information, including drawings, illustrations and graphic designs, reflects our present understanding and is to the best of our knowledge and belief correct and reliable. Users, however, should independently evaluate the suitability of each product for the desired application.

